

## Surface Mount Super Fast Recovery Rectifier

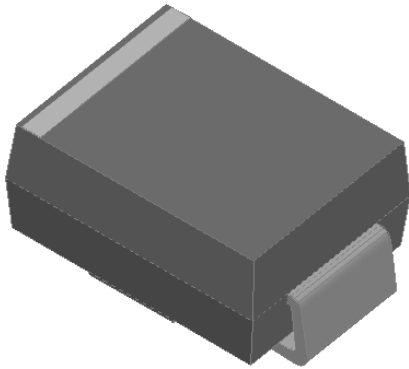

### Features

- Low profile package
- Ideal for automated placement
- Glass passivated chip junction
- High forward surge capability
- Super Fast reverse recovery time
- Meets MSL level 1, per J-STD-020, LF maximum peak of 260°C

### Typical Applications

For use in high frequency rectification of power supplies, inverters, converters, and freewheeling diodes for consumer and telecommunication.

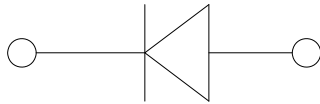

### Mechanical Data

- **Package:** DO-214AA (SMB)  
Molding compound meets UL 94 V-0 flammability rating, RoHS-compliant, halogen-free
- **Terminals:** Tin plated leads, solderable per J-STD-002 and JESD22-B102
- **Polarity:** Cathode line denotes the cathode end

### ■ Maximum Ratings ( $T_a=25^\circ\text{C}$ Unless otherwise specified)

PARAMETER	SYMBOL	UNIT	UG2A	UG2B	UG2C	UG2D	UG2F	UG2G	UG2H	UG2J
Device marking code			UG2A	UG2B	UG2C	UG2D	UG2F	UG2G	UG2H	UG2J
Maximum Repetitive Peak Reverse Voltage	VRRM	V	50	100	150	200	300	400	500	600
Maximum RMS Voltage	VRMS	V	35	70	105	140	210	280	350	420
Maximum DC blocking Voltage	VDC	V	50	100	150	200	300	400	500	600
Average rectified output current @60Hz sine wave, resistance load, TL (Fig.1)	$I_O$	A	2.0							
Forward Surge Current (Non-repetitive) @60Hz Half-sine wave, 1 cycle, $T_j=25^\circ\text{C}$	$I_{FSM}$	A	50							
Forward Surge Current (Non-repetitive) @1ms, square wave, 1 cycle, $T_j=25^\circ\text{C}$			100							
Current squared time @1ms≤t≤8.3ms $T_j=25^\circ\text{C}$	$I^2t$	A <sup>2</sup> s	10.375							
Storage temperature	$T_{stg}$	°C	-55 ~ +150							
Junction temperature	$T_j$	°C	-55 ~ +150							



# UG2A THRU UG2J

## ■ Electrical Characteristics (T<sub>a</sub>=25°C Unless otherwise specified)

PARAMETER	SYMBOL	UNIT	TEST CONDITIONS	UG2A	UG2B	UG2C	UG2D	UG2F	UG2G	UG2H	UG2J
Maximum instantaneous forward voltage	V <sub>F</sub>	V	I <sub>FM</sub> =2.0A	0.92			1.25		1.7		
Maximum reverse recovery time	t <sub>rr</sub>	ns	I <sub>F</sub> =0.5A, I <sub>R</sub> =1.0A, I <sub>rr</sub> =0.25A	25						35	
Maximum DC reverse current at rated DC blocking voltage	I <sub>R</sub>	μA	T <sub>j</sub> =25°C	5.0							
			T <sub>j</sub> =125°C	50							
Typical junction capacitance	C <sub>j</sub>	pF	Measured at 1MHz and Applied Reverse Voltage of 4.0 V.D.C	40			26		23		

## ■ Dynamic Characteristics

### ◆ UG2A THRU UG2D

PARAMETER	SYMBOL	UNIT	TEST CONDITIONS		Min	Typ	Max
Reverse Recovery Time	T <sub>RR</sub>	ns	T <sub>j</sub> =25°C	I <sub>F</sub> =1A, di/dt=-50A/us V <sub>RM</sub> =30V	-	26	-
			T <sub>j</sub> =25°C	I <sub>F</sub> =2A di/dt=-200A/us V <sub>RM</sub> =100V	-	23	-
			T <sub>j</sub> =125°C		-	30	-
Peak recovery current	I <sub>RRM</sub>	A	T <sub>j</sub> =25°C	I <sub>F</sub> =2A di/dt=-200A/us V <sub>RM</sub> =100V	-	3.1	-
			T <sub>j</sub> =125°C		-	5.0	-
Reverse recovery charge	Q <sub>rr</sub>	nC	T <sub>j</sub> =25°C	I <sub>F</sub> =2A di/dt=-200A/us V <sub>RM</sub> =100V	-	35.4	-
			T <sub>j</sub> =125°C		-	73.8	-
Non-repetitive avalanche energy	E <sub>AS</sub>	mJ	T <sub>j</sub> =25°C	I <sub>R</sub> =1.8 A, L=15 mH	24.3	-	-

### ◆ UG2F THRU UG2G

PARAMETER	SYMBOL	UNIT	TEST CONDITIONS		Min	Typ	Max
Reverse Recovery Time	T <sub>RR</sub>	ns	T <sub>j</sub> =25°C	I <sub>F</sub> =1A, di/dt=-50A/us V <sub>RM</sub> =30V	-	26	-
			T <sub>j</sub> =25°C	I <sub>F</sub> =2A di/dt=-200A/us V <sub>RM</sub> =200V	-	24	-
			T <sub>j</sub> =125°C		-	36	-
Peak recovery current	I <sub>RRM</sub>	A	T <sub>j</sub> =25°C	I <sub>F</sub> =2A di/dt=-200A/us V <sub>RM</sub> =200V	-	2.7	-
			T <sub>j</sub> =125°C		-	4.5	-
Reverse recovery charge	Q <sub>rr</sub>	nC	T <sub>j</sub> =25°C	I <sub>F</sub> =2A di/dt=-200A/us V <sub>RM</sub> =200V	-	32.3	-
			T <sub>j</sub> =125°C		-	82.8	-
Non-repetitive avalanche energy	E <sub>AS</sub>	mJ	T <sub>j</sub> =25°C	I <sub>R</sub> =0.5A, L=15 mH	1.9	-	-

### ◆ UG2H THRU UG2J

PARAMETER	SYMBOL	UNIT	TEST CONDITIONS		Min	Typ	Max
Reverse Recovery Time	T <sub>RR</sub>	ns	T <sub>j</sub> =25°C	I <sub>F</sub> =1A, di/dt=-50A/us V <sub>RM</sub> =30V	-	40	-
			T <sub>j</sub> =25°C	I <sub>F</sub> =2A di/dt=-200A/us V <sub>RM</sub> =400V	-	38	-
			T <sub>j</sub> =125°C		-	59	-
Peak recovery current	I <sub>RRM</sub>	A	T <sub>j</sub> =25°C	I <sub>F</sub> =2A di/dt=-200A/us V <sub>RM</sub> =400V	-	4.2	-
			T <sub>j</sub> =125°C		-	6.5	-
Reverse recovery charge	Q <sub>rr</sub>	nC	T <sub>j</sub> =25°C	I <sub>F</sub> =2A di/dt=-200A/us V <sub>RM</sub> =400V	-	78.9	-
			T <sub>j</sub> =125°C		-	192.7	-
Non-repetitive avalanche energy	E <sub>AS</sub>	mJ	T <sub>j</sub> =25°C	I <sub>R</sub> =0.7A, L=15 mH	3.7	-	-



# UG2A THRU UG2J

## ■ Thermal Characteristics (T<sub>a</sub>=25°C Unless otherwise specified)

PARAMETER	SYMBOL	UNIT	UG2A	UG2B	UG2C	UG2D	UG2F	UG2G	UG2H	UG2J
Typical Thermal resistance	R <sub>θJ-A</sub> <sup>(1)</sup>	°C/W	70							
	R <sub>θJ-L</sub> <sup>(1)</sup>		20							
	R <sub>θJ-C</sub> <sup>(1)</sup>		15							

Note:  
 (1) Thermal resistance from junction to ambient and from junction to lead mounted on P.C.B. with 0.3" x 0.3" (8.0 mm x 8.0 mm) copper pad areas

## ■ Characteristics (Typical)

FIG.1: I<sub>o</sub>-T<sub>L</sub> Curve

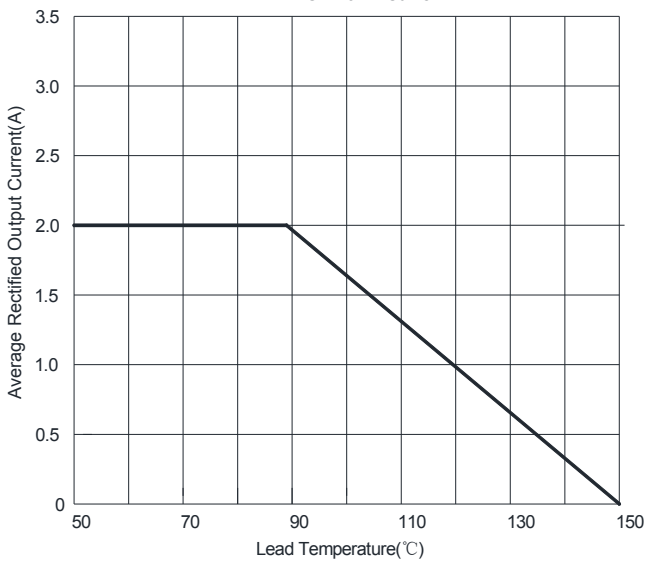

FIG2: Surge Forward Current Capability

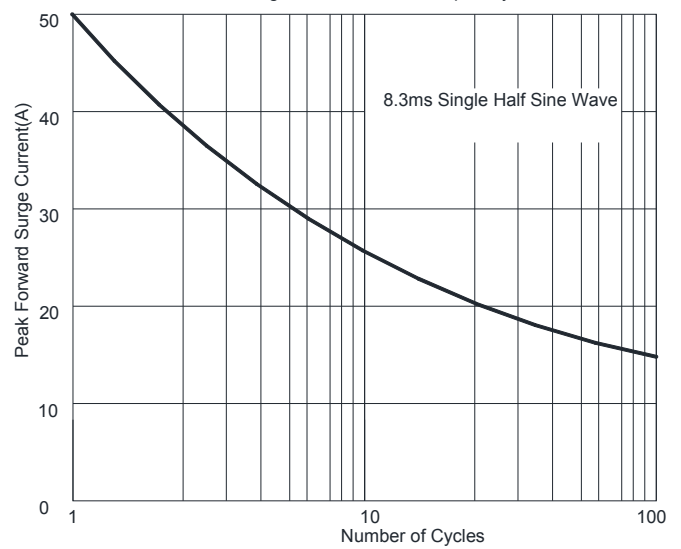

FIG.3: Typical Forward Characteristics

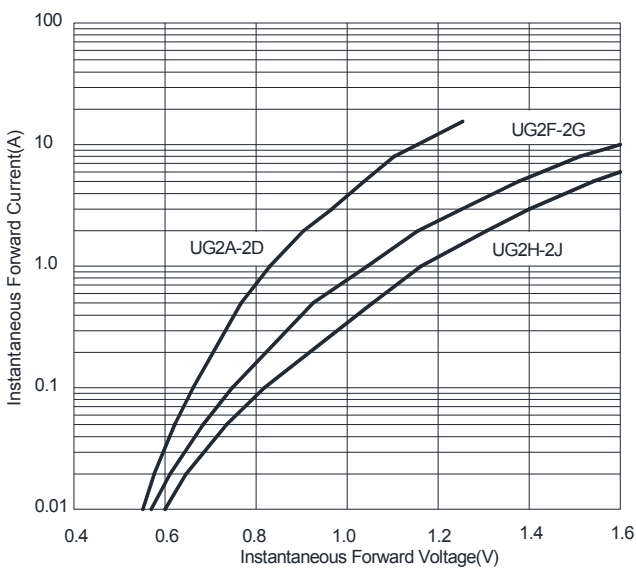

FIG4: Typical Reverse Characteristics

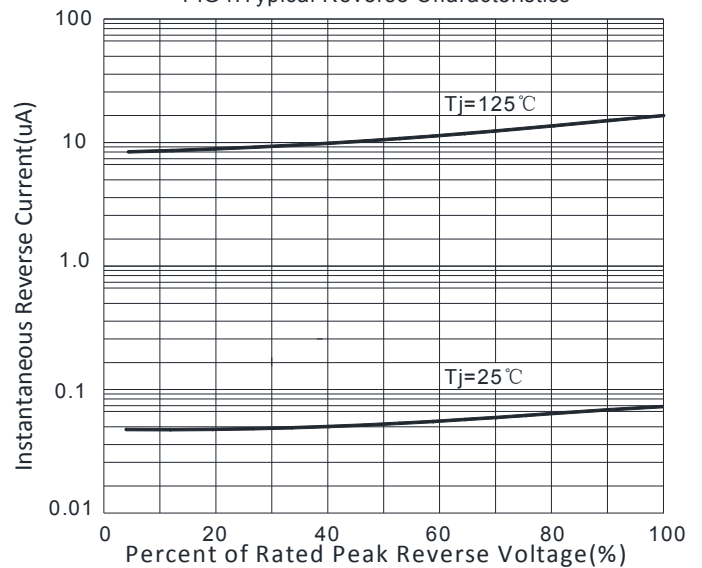
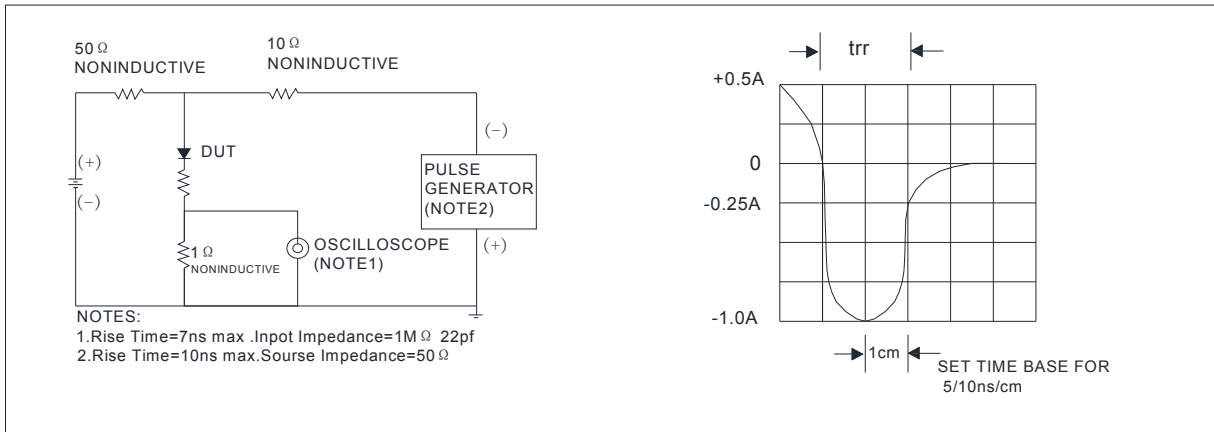

FIG.5: Diagram of circuit and Testing wave form of reverse recovery time



## Ordering Information (Example)

PREFERRED P/N	PACKING CODE	UNIT WEIGHT(g)	MINIMUM PACKAGE(pcs)	INNER BOX QUANTITY(pcs)	OUTER CARTON QUANTITY(pcs)	DELIVERY MODE
UG2A-UG2J	F1	Approximate 0.096	3000	/	48000	13" reel
UG2A-UG2J	F2	Approximate 0.096	750	6000	24000	7" reel
UG2A-UG2J	F3	Approximate 0.096	500	4000	16000	7" reel

## Outline Dimensions

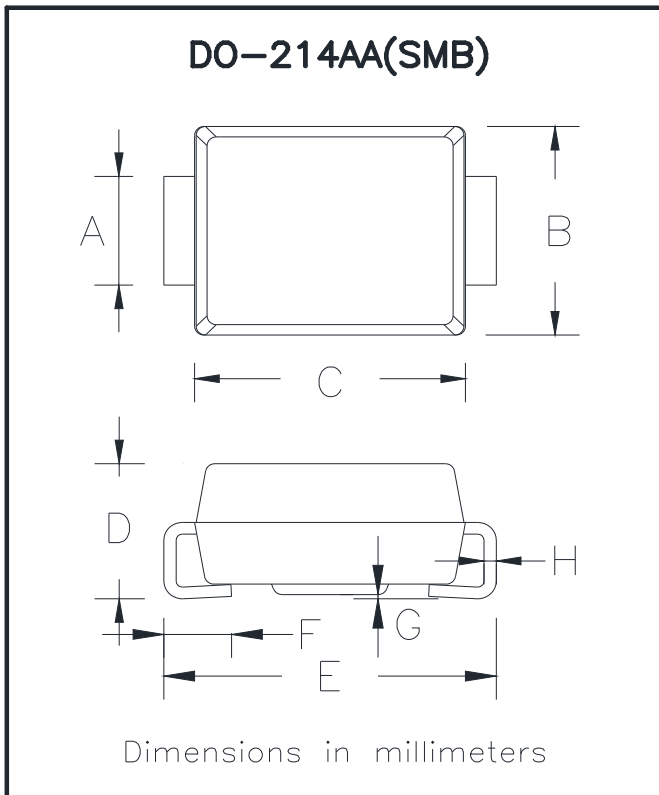

DO-214AA(SMB)		
Dim	Min	Max
A	1.85	2.15
B	3.30	3.94
C	4.05	4.75
D	1.99	2.61
E	5.21	5.59
F	0.90	1.41
G	0.10	0.20
H	0.15	0.31



## UG2A THRU UG2J

### ■ Suggested pad layout

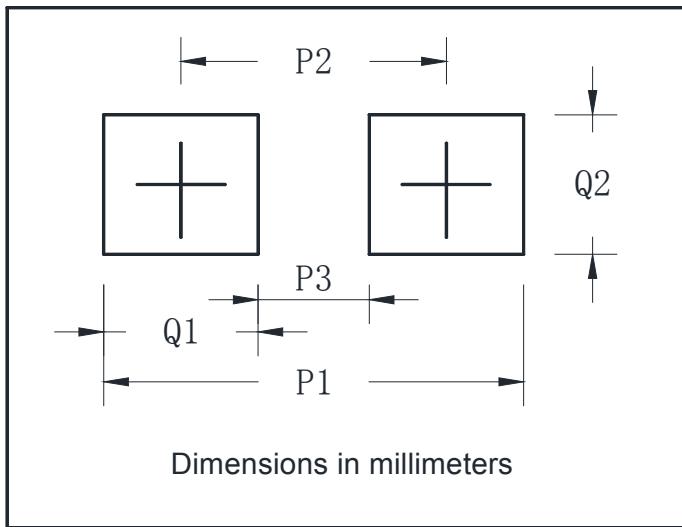

DO-214AA(SMB)	
Dim	Millimeters
P1	6.8
P2	4.3
P3	1.8
Q1	2.5
Q2	2.3



## UG2A THRU UG2J

---

### Disclaimer

The information presented in this document is for reference only. Yangzhou Yangjie Electronic Technology Co., Ltd. reserves the right to make changes without notice for the specification of the products displayed herein to improve reliability, function or design or otherwise.

The product listed herein is designed to be used with ordinary electronic equipment or devices, and not designed to be used with equipment or devices which require high level of reliability and the malfunction of which would directly endanger human life (such as medical instruments, transportation equipment, aerospace machinery, nuclear-reactor controllers, fuel controllers and other safety devices), Yangjie or anyone on its behalf, assumes no responsibility or liability for any damages resulting from such improper use of sale.

This publication supersedes & replaces all information previously supplied. For additional information, please visit our website [http:// www.21yangjie.com](http://www.21yangjie.com) , or consult your nearest Yangjie's sales office for further assistance.